

PWM Fan Motor Driver with Slope Control and Low Duty Startup

DESCRIPTION

EUM6882 is a fan motor driver for brushless DC fan motor. It integrates three types speed control modes, low duty startup function, soft switched output, lock protection, Hall bias, FG output, shutdown mode, quick restart and TSD. With these modes and functions, EUM6882 can not only be applied to DC fans which require different speed curves, but also be applied to NB and other portable equipments which require silence and low power dissipation.

The three types speed control modes are PWM control mode, VCC control mode with slope adjustable, normal VCC control mode. Low duty startup function makes it possible for DC fan to start and restart under a very low PWM duty cycle. Soft switched output drives DC fan in low noise and low vibration. If a DC fan is stalled by the external force or obstacles, overdrive current may incur coil overheat and burning. To prevent motor from overheating, the lock protection circuit shuts down the internal power devices for a few seconds after the motor lock is detected. Then the auto restart circuit resumes to power up the internal power devices. EUM6882 has built in Hall IC bias output, motor rotation speed feedback (FG). With its shutdown mode and quick restart, EUM6882 consume little power dissipation during shutdown time and can be started at once regardless of lock detection time.

FEATURES

- Single-Phase Full-Wave Driver System
- Three Speed Control Mode
PWM Control Mode
VCC Control Mode with Slope Adjustable
Normal VCC Control Mode
- Low Duty Startup
SD = H: Enable Low Duty Startup
SD = L: Disable Low Duty Startup
- Soft Switched Drive for Silent Application
- Lock Detection and Automatic Restart
- Shutdown Mode and Quick Restart
Low Standby Current (PWM = L)
- FG Output
- Hall Bias Output
- Thermal Shutdown Protection
- Available in UDFN-10 Package
- RoHS Compliant and 100% Lead (Pb)-Free
Halogen-Free

APPLICATIONS

- NB Cooling Fan
- Silent Fan Motor

Application Circuit

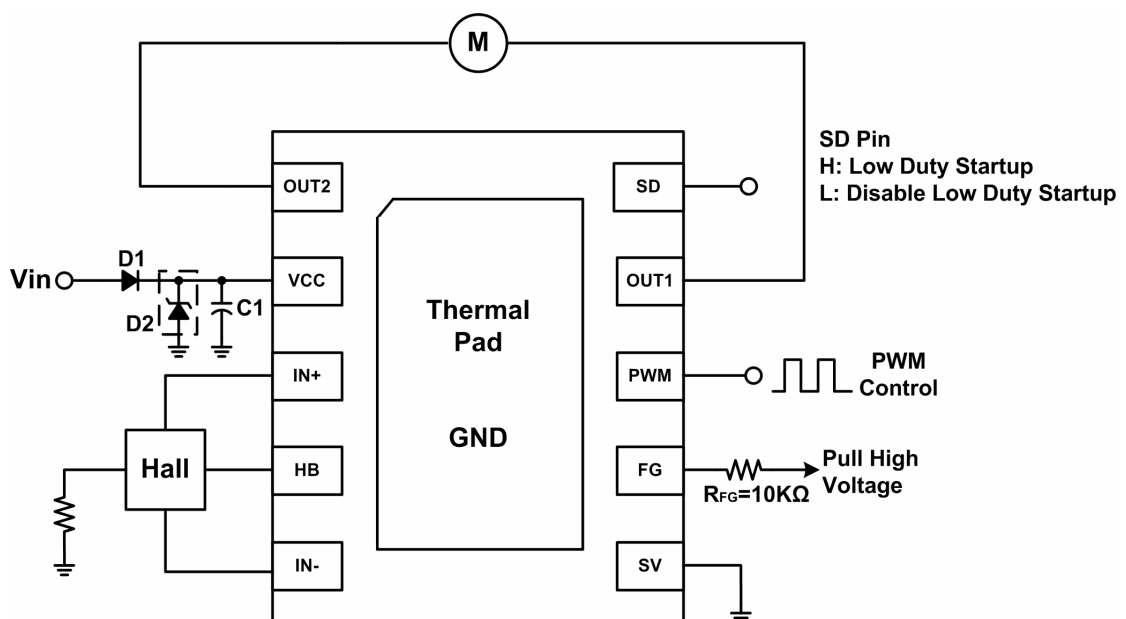

Figure 1. PWM Control Mode